

Konferenzsysteme

Conference systems
Systèmes de conférence

hund
möbelwerke

Aus Tradition Neues schaffen.



SIE ERWARTEN BESTEN SERVICE UND KNOW-HOW.

*You expect the best service and know-how.
Vous attendez le meilleur service et du savoir-faire.*

Mit unseren Büroeinrichtungskonzepten wollen wir das moderne Arbeiten ergonomischer, funktioneller und stilvoller machen und Menschen für ihr Arbeitsumfeld begeistern. Wir haben es uns zur Aufgabe gemacht, intelligente Büromöbelsysteme und Inneneinrichtungslösungen für den Geschäftskundenbereich zu entwickeln und zu produzieren. Dabei ist es uns wichtig, unseren Kunden den optimalen Mehrwert durch industrielle Serienfertigung und die hauseigene Manufaktur zu bieten. Unser Ziel ist es, eine ideale Büroeinrichtung nach bedarfsorientiertem Planungsprinzip zu ermöglichen.

OBERFLÄCHEN WIRKEN LASSEN.

Oberflächen spielen bei der Möbel- und Arbeitsraumgestaltung eine wichtige Rolle. Farben und Furniere dienen als Strukturierungs- und Stilelemente, die jedem Raum eine individuelle Note verleihen. Deshalb bieten wir unseren Kunden ein breites Spektrum an Farb- und Furniermöglichkeiten.



FURNIERE

Wir lieben Furniere. Sie gehören zum Edelsten, was aus Holz hergestellt werden kann. Furniere sind ein Spiegel der Natur.

Bei Hund Möbelwerke wird das jahrtausendealte Veredelungsverfahren des Furnierens für die stilvolle Oberflächengestaltung von Konferenzanlagen, Einrichtungen für Geldinstitute und Empfangsanlagen eingesetzt. So wird aus jedem Möbel ein individuelles Unikat.

KONFERENZSYSTEME

*Conference systems
Systèmes de conférence*



METACON

4 - 21

KOMMUNIKATION SUCHT KONZENTRATION.

Communication is looking for concentration.

Communication a la recherche de concentration.



BESPRECHUNGSTISCHE

22 - 35

CONFERENCE TABLES / TABLES DE CONFÉRENCE

QUALITÄT UND STIL IN JEDER BESPRECHUNG.

Quality and style at every meeting.

Qualité et style pour toute réunion.

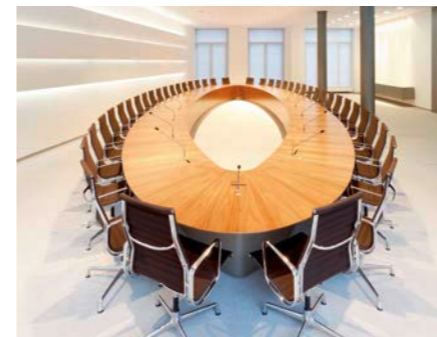

MANUFAKTUR

36 - 41

MANUFACTURE / MANUFACTURE

DIE AUSNAHME BEDARF DER INDIVIDUALITÄT.

Individuality demands exception.

L'exception requiert de l'individualité.



www.blauer-engel.de/uz38

- emissionsarm
- Holz aus nachhaltiger Forstwirtschaft
- in der Wohnumwelt gesundheitlich unbedenklich

PRODUKTÜBERSICHT

Product overview

Vue d'ensemble des produits

42 - 44

METACON

KOMMUNIKATION SUCHT KONZENTRATION.

Communication is looking for concentration.

Communication a la recherche de concentration.

Kommunikation ist essentiell. Wer sich anderen mitteilen will, muss kommunizieren können. Im täglichen Geschäftsleben sind wichtige Gespräche, deutliche Worte und rasche Absprachen wesentlich. Zu optimalen Kommunikationsstrategien gehört ohne Zweifel ein Höchstmaß an Konzentration. Um sich der ungeteilten Aufmerksamkeit seines Gegenübers sicher zu sein, ist ein passendes Umfeld notwendig: Frei von unerwünschter Ablenkung und mit viel Platz für alle Unterlagen. Wenn ein Gesprächspartner genügend Bewegungsfreiheit hat, entsteht schnell eine positive Atmosphäre, die beste Arbeitsverhältnisse schafft. Die Voraussetzung ist hier jedoch, dass durch Flexibilität und leicht veränderbare Gegebenheiten reichlich Spielraum für alle » Konzentrationsfähigen und Kommunikationswilligen « entsteht.

Communication is essential. Those who want to share with others must be able to communicate. In daily business, important conversations, clear words and fast agreements are fundamental. Without doubt, a high level of concentration belongs to any optimal communication strategy. In order to be able to guarantee the undivided attention of others, a fitting environment is necessary: free from undesired distractions and lots of space for all of your documents. If a conversational partner has enough mobility, a positive atmosphere will quickly arise – which allows for the best working conditions possible. The requirement here, however, is that through flexibility and easily changeable conditions, there is enough space for all » those capable of concentrating and those willing to communicate «.

Communication est essentielle. Celui qui souhaite transmettre ses idées, doit maîtriser l'art de la communication. Dans le business quotidien, les entretiens importants, les mots clairs et des ententes rapides sont primordiaux. Un maximum de concentration est sans aucun doute nécessaire aux stratégies de communication optimisées. Afin de pouvoir compter sur toute l'attention de l'interlocuteur, il semble indispensable de disposer d'un environnement approprié : Sans distractions indésirables et avec plein d'espace pour tous les documents. Si l'interlocuteur dispose de suffisamment de liberté de mouvement, une atmosphère positive, indispensable aux bonnes conditions de travail, se crée rapidement. La condition préalable est toutefois que la flexibilité et les dispositions facilement modifiables permettent suffisamment de latitude pour tous ceux « souhaitant se concentrer et étant disposés à communiquer ».













Rack types and versions

Types de piètement et de versions



Swing

Swing

Swing



TA Rechtecksäule

Säule in Graphit.
Ausleger in Chromoptik.

TA rectangle column

Column in graphite.
Beam in chrome look.

Colonne rectangulaire TA

Colonne en graphite.
Console d'aspect chromé.



TA Rechtecksäule

Säule und Ausleger in Graphit.

TA rectangle column

Column and beam in graphite.

Colonne rectangulaire TA

Colonne et console en graphite.



TA Rundsäule

Säule in Graphit.
Ausleger in Chromoptik.

TA round column

Column in graphite.
Beam in chrome look.

Colonne arrondie TA

Colonne en graphite.
Console d'aspect chromé.



TA Rundsäule

Säule und Ausleger in Graphit.

TA round column

Column and beam in graphite.

Colonne arrondie TA

Colonne et console en graphite.



TA Rundsäule

Säule in Weißaluminium.
Ausleger in Chromoptik.

TA round column

Column in white aluminium.
Beam in chrome look.

Colonne arrondie TA

Colonne en aluminium blanc.
Console d'aspect chromé.



TA Rechtecksäule

Säule in Weißaluminium.
Ausleger in Chromoptik.

TA rectangle column

Column in white aluminium.
Beam in chrome look.

Colonne rectangulaire TA

Colonne en aluminium blanc.
Console d'aspect chromé.



TA Rechtecksäule

Säule und Ausleger
in Weißaluminium.

TA rectangle column

Column and beam
in white aluminium.

Colonne rectangulaire TA

Colonne et console
en aluminium blanc.



TA Rechtecksäule

Als Abschlussfuß. Säule in Graphit.
Ausleger in Chromoptik.

TA rectangle column

As a finish base. Column in graphite.
Beam in chrome look.

Colonne rectangulaire TA

Comme pied de finition. Colonne en graphite.
Console d'aspect chromé.



TA Rundsäule

Säule und Ausleger
in Weißaluminium.

TA round column

Column and beam
in white aluminium.

Colonne arrondie TA

Colonne et console
en aluminium blanc.



Gestellanbindung an Platte

Mit Spezialverschluss.

Frame connections on the panel

With special closure.

Raccordement piètement sur plateau

Avec verrouillage spécial.



Electric cover, long

Equipped with 1 6-panel outlet, 3 x shock-proof plug and 3 x optional with media technology modules, here with a VGA-connection (analog) with mini-pin BCM-4K, 2 x RJ-45 CAT5E-connection for LAN connections, DVI-connection (digital) with mini-pin BCM-14A.

E-Klappe, lang

Bestückt mit 1 6-fach Steckdose, 3 x Schuko fest und 3 x frei wählbar mit Medientechnikmodulen, hier mit VGA-Anschluss (analog) mit Miniklinke BCM-4K, 2 x RJ-45 CAT5E-Anschluss für LAN-Verbindungen, DVI-Anschluss (digital) mit Miniklinke BCM-14A.

E-Box, long

Equipé de 1 prise de courant sextuple dont 3 x avec terre fixe et 3 x à choisir librement pour modules IT, ici avec prise VGA (analogique), prise mini-jack BCM-4K, 2 x prises RJ-45 CAT5E pour raccordements LAN, branchement DVI (numérique) avec mini-jack BCM-14A.



E-Klappe, lang

Geschlossen.

Electric cover, long

Closed.

E-Box, long

Fermé.



Electric window

Equipped with 2 3-panel outlets, each 1 x shock-proof plug and 2 x optional with media technology modules, here with a VGA connection (analog), USB 2.0 A-connection, 2 x RJ-45 CAT5E-connection for LAN connections, VGA-connection (analog) with mini-pin BCM-4K.

E-Fenster

Bestückt mit 2 3-fach Steckdosen, jeweils 1 x Schuko fest und 2 x frei wählbar mit Medientechnikmodulen, hier mit VGA-Anschluss (analog), USB 2.0 A-Anschluss, 2 x RJ-45 CAT5E-Anschluss für LAN-Verbindungen, VGA-Anschluss (analog) mit Miniklinke BCM-4K.

E-fenêtre

Equipé de 2 prises de courant triples, chacune 1 x avec terre et 2 x à choisir librement pour modules IT, ici avec prise VGA (analogique), prise USB 2.0A, 2 x prises RJ-45 CAT5E pour raccordements LAN, branchement VGA (analogique) avec prise mini-jack BCM-4K.



E-Fenster

Geschlossen.

Electric window

Closed.

E-fenêtre

Fermé.



Electric cover, short

Equipped with 1 3-panel outlet, 1 x shock-proof plug and 2 x optional with media technology modules, here with 2 x RJ-45 CAT5E-connection for LAN-connections, VGA-connection (analog) with mini-pin BCM-4K.

E-Klappe, kurz

Bestückt mit 1 3-fach Steckdose, 1 x Schuko fest und 2 x frei wählbar mit Medientechnikmodulen, hier 2 x RJ-45 CAT5E-Anschluss für LAN-Verbindungen, VGA-Anschluss (analog) mit Miniklinke BCM-4K.

E-Box, court

Equipé de 1 prise de courant triples, 1 x avec terre fixe et 2 x à choisir librement pour modules IT, ici avec deux prises RJ-45 CAT5E pour raccordements LAN, branchement VGA (analogique) avec prise mini-jack BCM-4K.



E-Klappe, kurz

Geschlossen.

Electric cover, short

Closed.

E-Box, court

Fermé.



HDMI Anschluss

HDMI connection

Raccordement HDMI



LAN-Anschluss

2 x RJ-45 CAT6.

LAN connection

2 x RJ-45 CAT6.

Raccordement LAN

2 x RJ-45 CAT6.



USB 2.0 A-Anschluss

Einfach.

USB 2.0 A-connection

Single type.

Raccordement USB 2.0 A

Simple.



Netbox

Bestückt mit 1 4-fach Steckdose,
3 x Schuko fest und 2 x RJ-45
CAT5E-Anschluss fest.

Netbox

*Version: anodized aluminium, equipped with 1 4-socket outlet,
3 x Schuko fixed, 2 x RJ-45 CAT5E connection fixed.*

Netbox

*Finition : aluminium anodisé, équipé de 1 prise de courant
quadruple, 3 x avec terre et 2 x prises RJ-45 CAT5E fixes.*



Netbox

Geschlossen.

Netbox,

Closed.

Netbox

Fermé.



Kabelbügel

Ausführung: Graphit.

Cable clips

Version: graphite.

Étrier de câble

Finition : graphite.



VGA-Anschluss (analog)

15-polig.

VGA connection (analog)

15-pin.

Raccordement VGA (analogique)

15 broches.



VGA-Anschluss (analog)

15-polig mit Miniklinke BCM-4K.

VGA connection (analog)

15-pin with mini-pin BCM-4K.

Raccordement VGA (analogique)

15 broches avec mini-jack BCM-4K.



DVI-Anschluss (digital)

Mit Miniklinke BCM-14A.

DVI connection (digital)

With mini-pin BCM-14A.

Raccordement VGA (numérique)

Avec mini-jack BCM-14A.



E-Rahmen

Geschlossen.

Electric frame

Geschlossen.

E-Cadre

Geschlossen.



Einbau-Steckdose

1-fach mit RJ45- und USB oder HDMI-
Anschluss. Ausführung: Alu eloxiert.

Installed outlet

Single with RJ45 and USB or HDMI connection.

Version: anodized aluminium.

Prise encastrée

1 prise avec port RJ45 et port USB ou la HDMI.

Finition : aluminium anodisé.

BESPRECHUNGSTISCHE

CONFERENCE TABLES/TABLES DE CONFÉRENCE

QUALITÄT UND STIL IN JEDER BESPRECHUNG.

Quality and style at every meeting.

Qualité et style pour toute réunion.

Grundlagen. Durchdachte Kommunikationsmittel sind die Basis für erfolgreiche Besprechungen und werden in nahezu allen Arbeitsbereichen benötigt. Die Anforderungen in Konferenz- und Besprechungssituationen steigen; die Abläufe werden immer weiter optimiert. Unsere Besprechungstische ermöglichen unkomplizierte Termine, effektive Gesprächsrunden oder ein kurzes Wort zwischen Kollegen. Der » workflow « wird nicht durch störende Nebensächlichkeiten wie starre Strukturen oder einem Mangel an Funktionalität beeinträchtigt. Hund Möbelwerke bietet Ihnen im wahrsten Sinn des Wortes eine optimale Grundlage. Perfekt flexibel für Ihren Alltag und Ihren Erfolg!

Basics. Well thought-out communication mediums are the basis for successful meetings and are needed in nearly all working areas. The demands in conference and meeting situations increase; procedures are always being optimized. Our conference tables allow for uncomplicated meetings and for both effective conversations and quick conversations with colleagues. The work-flow will not be affected by disruptive distractions like non-adjustable structures or a lack of functionality. Hund Möbelwerke literally offers you an optimal basis. Perfectly flexible for your everyday use and success!

Bases. Les moyens de communication bien pensés sont la base de réunions réussies ; ils sont indispensables dans quasiment tous les secteurs de travail. Les exigences des conférences et réunions augmentent, leur déroulement est de plus en plus optimisé. Nos tables de conférence permettent autant des réunions informelles que des négociations efficaces ou un rapide entretien entre collègues. Le « flux de travail » n'est pas freiné par des accessoires qui dérangent, comme les structures rigides ou un manque de fonctionnalité. Hund Möbelwerke vous offre véritablement une base optimisée. Parfaitement flexible pour votre quotidien et votre succès !











FORMEN UND TECHNIK

Forms and technology
Formes et technique



Runder Tisch mit Säulenfußgestell

Rasterhöhenverstellbar 680–820 mm. Auch starr, 720 mm hoch erhältlich.

Round table with column-shaped base

Adjustable height 680–820 mm. Also available fixed, 720 mm high.

Table ronde avec pied colonne

Réglable en hauteur par paliers 680–820 mm.

Disponible également avec une hauteur fixe de 720 mm.



Runder Tisch mit Säulenfußgestell

Komforthöhenverstellbar 720–1160 mm.

Round table with column-shaped base

Comfort-adjustable height 720–1160 mm.

Table ronde avec pied colonne

Réglable en hauteur pour confort 720–1160 mm.



Runder Tisch auf Rollen

Komforthöhenverstellbar 720–1160 mm.

Round table on wheels

Comfort-adjustable height 720–1160 mm.

Table ronde sur roulettes

Réglable en hauteur pour confort 720–1160 mm.



Rechtecktisch als Steh/Sitz

Elektromotorisch höhenverstellbar 650–1250 mm.

Rectangular table as stand or sit

Electronically actuated height adjustable from 650–1250 mm.

Table rectangulaire comme table debout/assis

Avec réglage d'hauteur motorisé de 650–1250 mm.



Tonnenformtisch mit Säulenfußgestell

Rasterhöhenverstellbar 680–820 mm. Auch starr, 720 mm hoch erhältlich.

Barrel form table with column-shaped base

Adjustable height 680–820 mm. Also available fixed, 720 mm high.

Table en forme de tonneau avec pied colonne

Réglable en hauteur par paliers 680–820 mm.

Disponible également avec une hauteur fixe de 720 mm.



Eckiger Tisch

Starr, 720 mm hoch. Auch Raster- und Komforthöhenverstellbar erhältlich.

Square table

Fixed, 720 mm high. Also available with module and comfort height adjustment.

Table carrée

Hauteur fixe de 720 mm. Disponible également en version avec un réglage facile

de la hauteur et avec une hauteur réglable par paliers.



Vierfuß-Besprechungstisch

Starr, 720 mm hoch.

Four leg conference table

Fixed, 720 mm high.

Table de conférence à quatre pieds

Hauteur fixe de 720 mm.

FORMEN UND TECHNIK

Forms and technology
Formes et technique



Schwenktisch
Starr, 740 mm hoch, mit Hebelverbinder.

Rotary table
Fixed, 740 mm high, with lever link.

Table rotative
Hauteur fixe de 740 mm, avec lien de levier.



Schwenktisch
Zusammengeklappt, mit Hebelverbinder.

Rotary table
Folded, with lever link.

Table rotative
Rabattue, avec lien de levier.



Klapptisch
Starr, 1070 mm hoch.

Folding table
Fixed, 1070 mm high.

Table rabattable
Hauteur fixe de 1070 mm.



Klapptisch
Zusammengeklappt.

Folding table
Folded.

Table rabattable
Rabattue.

BESPRECHUNGSTISCHE



Hochbrücke

Viaduct

Console haute



Redner-/Beamerpult
Komforthöhenverstellbar 720–1160 mm. Auch starr und rasterhöhenverstellbar erhältlich.

Speaker/operator desk
Comfort height adjustment 720–1160 mm. Also available as fixed and module height adjustable.

Tabouret orateur/projecteur
Réglable facile de la hauteur entre 720–1160 mm. Disponible également en version à hauteur fixe et réglable en hauteur par paliers.



Flipchart

Flip chart

Tableau à feuilles mobiles

MANUFAKTUR

MANUFACTURE/MANUFACTURE

DIE AUSNAHME BEDARF DER INDIVIDUALITÄT.

Individuality demands exception.

L'exception requiert de l'individualité.

Maßarbeit. Wir bieten unseren Kunden individuelle Lösungen und maßgeschneiderte Konzepte an. Denn die meisten Arbeitsplätze benötigen keine Standardisierung, sondern Individualisierung! Jedes Unternehmen unterscheidet sich schließlich bezüglich Partner, Konkurrent oder Gegenüber, zum Beispiel im Bereich der Corporate Architecture. Hund Möbelwerke leistet hier ganze Arbeit in den Bereichen Entwicklung, Planung und Produktion. Unser wichtigstes Kriterium ist höchste Qualität bis ins kleinste Detail! Um ein zufriedenstellendes und optimales Ergebnis zu erhalten, sei es für eine komplizierte Aufgabe oder weitreichende Veränderungen, wird viel Aufmerksamkeit benötigt. Allerdings – in unserer Manufaktur finden wir keine Lösungen: Wir schaffen sie! Nur für Sie. Speziell für Ihre Details.

Precision work. We offer our customers individual solutions and custom-designed concepts. Most work spaces do not require standardization, but rather individualization! The demands for your company are clearly different than those from your partner, competitor or your counterpart – for example, in the corporate architecture field. Hund Möbelwerke does work in the areas of development, planning and production. Our most important criterion is the highest quality down to the smallest details! In order to receive a satisfactory and optimal resort, whether it is for a complicated task or for far-reaching changes, a lot of attention and care is required. However – we don't find any solutions in our company: We create them! Just for you. Specifically for your minutiae.

Travail sur mesure. Nous proposons à nos clients des solutions individuelles et des conceptions sur mesure. Car la majorité des postes de travail ne nécessite pas de standardisation, mais de la personnalisation ! Ce que l'on attend de votre entreprise est nettement différent de ce que l'on attend de votre partenaire, concurrent ou votre vis à vis, par exemple dans le domaine de l'architecture corporative. Hund Möbelwerke contribue ici au beau travail au niveau du développement, de la planification et de la production. Notre critère le plus important est la plus grande qualité jusqu'au plus petit détail ! Beaucoup d'attention est nécessaire pour obtenir un résultat satisfaisant et optimal que ce soit pour une tâche complexe ou des modifications importantes. Toutefois – nous ne trouvons pas les solutions dans notre manufactory : Nous les créons ! Pour vous, exclusivement. Spécialement en fonction de vos exigences.

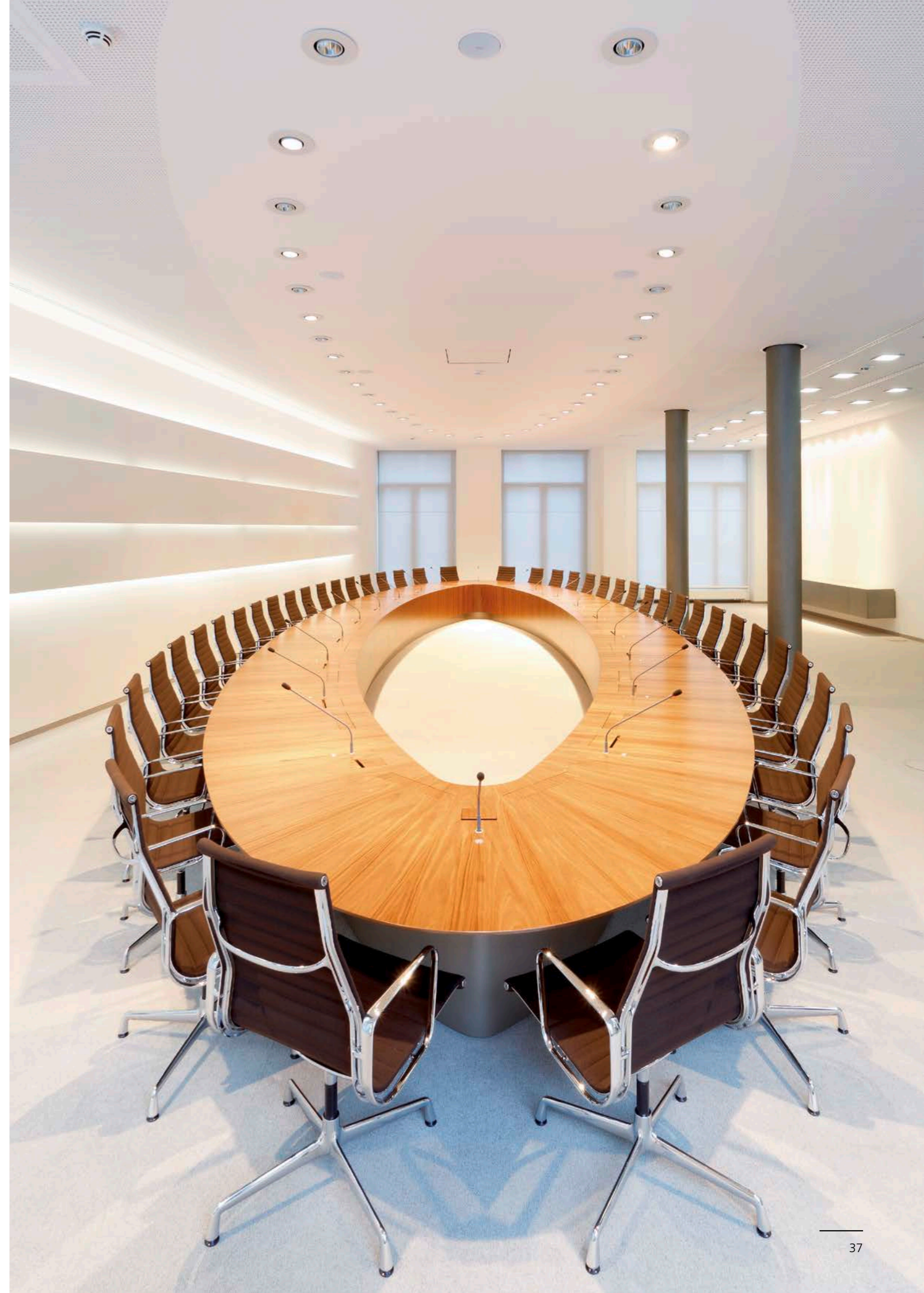





GESTELLTYPEN

Rack types
Piètements

AUSFÜHRUNGEN

Versions
Versions

PLATTENFORMEN

Panel shapes
Formes du plateau

Besprechungstische
Conference tables
Tables de conférence

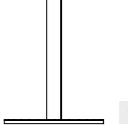
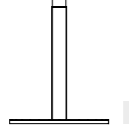
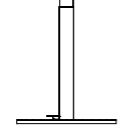
<p>Starr Non-adjustable Rigide</p> <p>720/1120</p>  <p>1</p>	<p>Raster-Höhenverstellung Adjustable height Hauteur réglable par paliers</p> <p>620 – 820</p>  <p>2</p>	<p>Schnell-Höhenverstellung Quick-height adjustment Hauteur réglable rapide</p> <p>720 – 1160</p>  <p>3</p>
--	--	---





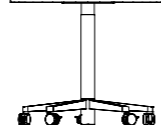

Graphit / Graphite / Graphite 1 2 3 4
 Weißaluminium / White aluminum / Aluminium blanc 1 2 3 4
 Barytweiß / Barite white / Blanc de baryte 1 2 3
 Edelstahl / Stainless steel / Acier inoxydable 1

Rollen
Wheels
Roulettes

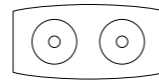

720 – 1160

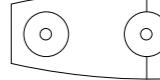
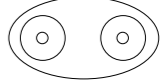

R 4

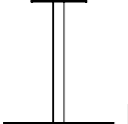
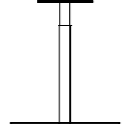
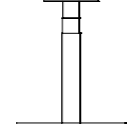
Ø 700  2000 x 800/1000 	Ø 800  2400 x 800/1100 	Ø 900  2800 x 800/1200 	Ø 1100  3600 x 800/1200 	2000 x 1100 
--	--	--	---	--

<p>Starr Non-adjustable Rigide</p> <p>720/1120</p>  <p>1</p>	<p>Raster-Höhenverstellung Adjustable height Hauteur réglable par paliers</p> <p>620 – 820</p>  <p>2</p>	<p>Elektromotorische Höhenverstellung Electromotive height adjustment Hauteur réglable électromoteur</p> <p>570 – 1170</p>  <p>3</p>
---	---	---

Graphit / Graphite / Graphite 1 2 3
 Weißaluminium / White aluminum / Aluminium blanc 1 2 3
 Barytweiß / Barite white / Blanc de baryte 1 2

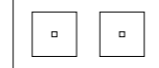
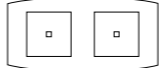
800 x 800

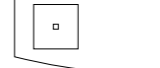
2000 x 1000 E 	2000 x 800/1000 E 	2400 x 800/1100 E 	2800 x 800/1200 E 
---	---	---	---

E Nur für elektromotorische Höhenverstellung
 Only for Electromotive height adjustment
 Seulement pour Hauteur réglable électromoteur









Vierfuß
Four foot table
Quatre pieds

720



1

Graphit / Graphite / Graphite 1
 Weißaluminium / White aluminum / Aluminium blanc 1

700 x 700 	800 x 800 	1200 x 800 	1400 x 700 	1600 x 800 	2000 x 1000 	1400 x 800 	2000 x 800/1000 
--	--	---	---	---	--	---	--

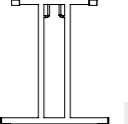
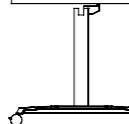
<p>Klapptisch Folding table Table pliable</p> <p>750</p>  <p>1</p>	<p>Schwenktisch Rotary table Table rotative</p> <p>745</p>  <p>2</p>
--	--







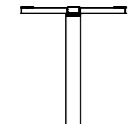
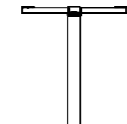
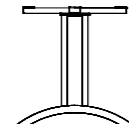







Graphit / Graphite / Graphite 1 2
 Weißaluminium / White aluminum / Aluminium blanc 1 2
 Chrom / Chrome / Chrome 1
 Fußausleger Alu poliert / 2
 Leg arm Alu polished / Base du pied Alu poli
 + Säule Graphit 2
 + Column Graphite / + Colonne Graphite
 + Säule Weißaluminium 2
 + Column White Aluminium / + Colonne Aluminium blanc

1400 x 700 	1600 x 800 
---	---

Metacon

<p>TA Rechtecksäule TA rectangle column Colonne rectangulaire TA</p> <p>720</p>  <p>1</p>	<p>TA Rundsäule TA round column Colonne arrondie TA</p> <p>720</p>  <p>2</p>	<p>Swing Swing Swing</p> <p>720</p>  <p>3</p>
---	--	---

Graphit / Graphite / Graphite 1 2
 Weißaluminium / White aluminum / Aluminium blanc 1 2
 Chrom / Chrome / Chrome 3
 Fußausleger Alu poliert / 1 2
 Leg arm Alu polished / Base du pied Alu poli
 + Säule Graphit 1 2
 + Column Graphite / + Colonne Graphite
 + Säule Weißaluminium 1 2
 + Column White Aluminium / + Colonne Aluminium blanc

800 x 800 	1200 x 800 	1400 x 800 	1600 x 800 	1800 x 800 	2000 x 800 	1600 x 800 	850 x 850 
2000 x 800/1000 	2400 x 1100/800 	1378 x 1151 	1400 x 1200 	1400 x 1200/800 	1800 x 1200/800 	1500 x 1200 	

OBERFLÄCHEN

Surfaces
Surfaces

Natursand	Natural sand/Sable naturel
Lichtgrau	Light-grey/Gris clair
Weiß	White/Blanc
Decor Ahorn	Maple laminate/Décor érable
Decor Havanna	Havanna laminate/Décor havanna
Decor Wildbuche	Wild beech laminate/Décor hêtre sauvage
Decor Eiche hell	Light-coloured oak laminate/Décor chêne clair
Decor Wenge hell	Light-coloured Wenge laminate/Décor bois wengé clair
Furnier Buche natur	Veneer beech natural/Placage hêtre naturel
Furnier Ahorn	Veneer maple/Placage érable
Furnier Eiche gekalkt	Veneer oak whitewashed/Placage chêne chaulé
Furnier Nussbaum	Veneer walnut/Placage noyer
Furnier Olivische	Veneer olive-ash/Placage frêne olive
Furnier Teak	Veneer teak/Placage teck
Furnier Räuchereiche	Veneer smoked Oak/Placage chêne fumé

Nicht für tonnen- und ellipsenförmige Tische, nicht für Tische mit elektromotrischer Höhenverstellung.

Not for barrel and elliptical tables, not for tables with electromotive height adjustment.

Les finitions suivantes ne sont pas compatibles avec plateaux plus long que 2000 mm.

Weiß/Weiß	White/White/Blanc/Blanc
Weiß/Graphit	White/Graphite/Blanc/Graphite



DIGITALE FARBCOLLAGE

DIGITAL COLOUR COLLAGE
COLLAGE DE COULEUR DIGITAL

Kombinieren Sie Farben und Oberflächen auf unserer Website.

Combine colours and surfaces on our website.

Combiner les couleurs et les surfaces sur notre site Web.



SIE ERWARTEN BESTEN SERVICE UND KNOW-HOW.

You expect the best service and know-how.

Vous attendez le meilleur service et du savoir-faire.



AKUSTIK

ACOUSTICS
ACOUSTIQUE

Individualschulung zum Thema
Raumakustik und OFML Akustik Plug In.

Individual training on the subject of space
acoustics and OFML Acoustics Plug In.

Formation individuelle sur le sujet de l'acoustique
spatiale et OFML Acoustics Plug In.



PLANUNGSDATEN

PLANNING DATA
DONNÉES DE PLANIFICATION

Hochwertige 3D-Darstellung, Planungs-
logik und vollständige Produktlogik.

High-quality 3D illustration, planning
logic and complete product logic.

Représentation réaliste en 3D, logique de
planification et logique complète du produit.



FARBEN & OBERFLÄCHEN

COLOURS AND SURFACES
COULEURS ET SURFACES

Digitale Farbcollage und Farbwelt
zur Unterstützung bei der Farbauswahl.

Digital colour collage and world of colour
assisting in the colour selection.

Collage de couleur digital et monde de couleurs
pour aider dans la sélection des couleurs.



SEMINARE & SCHULUNGEN

SEMINARS AND TRAINING
SÉMINAIRES ET FORMATION

Jährliche Seminar- und Schulungs-
angebote für unsere Fachhandelspartner.

Annual seminars and courses
for our retail partners.

Séminaires annuels pour
nos partenaires commerciaux.

hund
möbelwerke



B2B ONLINE SHOP

B2B ONLINE SHOP
BOUTIQUE EN LIGNE POUR B2B

Individualisierter Internetshop für
den Fachhandelspartner.

A customized Internet shop
for the specialized retail partner.

Boutique internet individualisée pour
le partenaire commercial.



PLANUNGSPRINZIP

PLANNING PRINCIPLE
PRINCIPE D'AMÉNAGEMENT

Digitaler Leitfaden für die perfekte
Büroraumgestaltung.

Digital guideline
for the perfect office design.

Guide numérique
pour la parfaite conception de l'espace du bureau.



SCHNELLIEFERSORTIMENT

FAST-DELIVERY-PRODUCT RANGE
ASSORTIMENT LIVRAISON EXPRESS

Lieferung von Starkläufermodellen
innerhalb von 11 Arbeitstagen.

Delivery of top-seller models
within 11 work days.

Livraison de modèles courants
dans les 11 jours ouvrables.



GEPR. BÜROEINRICHTER

CERTIFIED INTERIOR OFFICE DESIGNER
SPÉCIALISTE EN AGENCEMENT DE BUREAUX

Konzeption und Realisierung von Büro-
planungen durch qualifizierte Experten.

Conception and implementation
of office designing through qualified experts.

Conception et réalisation de planifications de
bureaux par expert architecte d'intérieur.

Aus Tradition Neues schaffen.

Hund Möbelwerke

GmbH & Co KG

Werk Biberach

Am Güterbahnhof 11

77781 Biberach/Baden

GERMANY

Telefon +49.7835.635-0

Telefax +49.7835.635-119

info@hund-moebel.de

Hund Möbelwerke

GmbH & Co KG

Informationszentrum

Schwanhäuser Straße 2

97528 Sulzdorf a. d. L.

GERMANY

Telefon +49.9763.9192-0

Telefax +49.9763.9192-19

info@hund-moebel.de

Ihr kompetenter Partner vor Ort

Your competent partner in your vicinity

Votre partenaire compétent sur site